

Music Man JP w/Piezo BECOS Micro Booster Installation Wiring Diagram

Drawing by BECOS
www.becos.ro

PICKUP SELECTOR SWITCH

Neck Mix Bridge
UP DOWN

ON-ON-ON

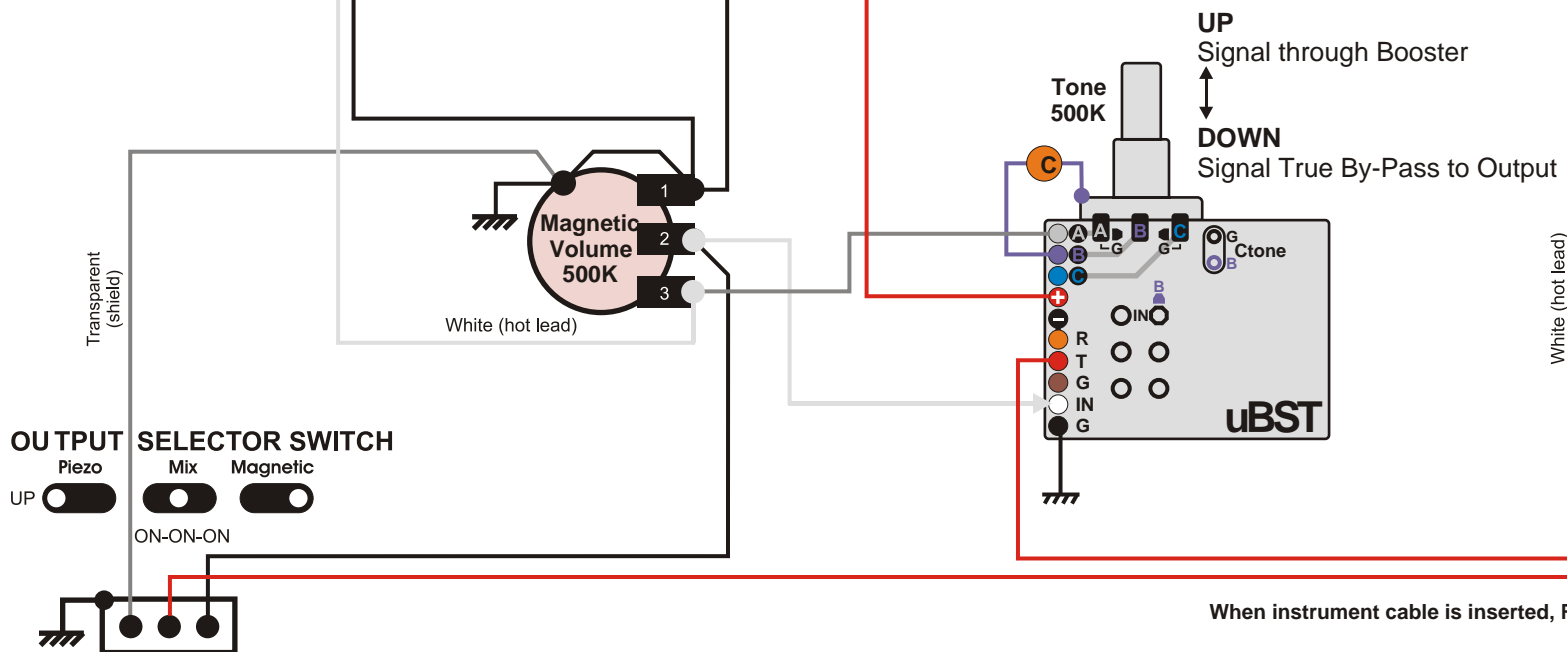
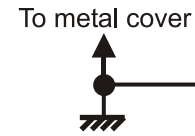
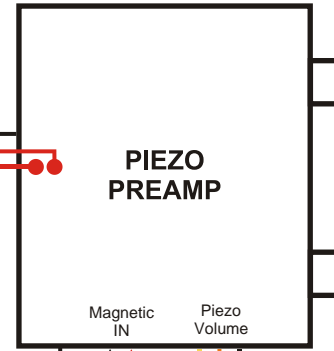
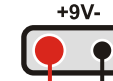
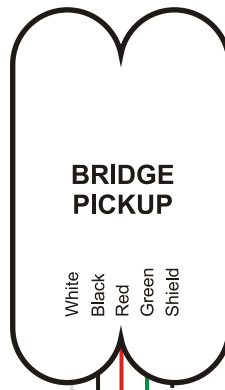
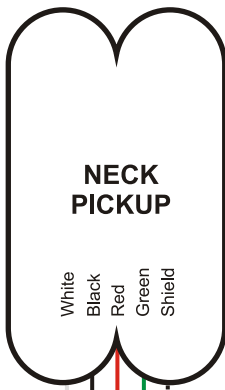
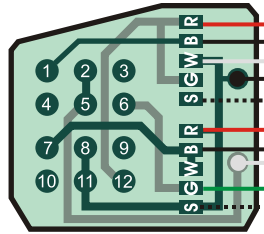

When instrument cable is inserted, Ring to Ground powers Booster circuit.

Disclaimer: You acknowledge that by opening the instrument and modifying the electronic circuit inside you will void manufacturer warranty. You, as a user, are the sole person responsible for the way you use this diagram. You are the only person in charge of solving electrical, mechanical or other technical problems that may arise upon using this information. The resulted electronic circuit is not subject to any warranty or support from the seller. We assume no responsibility for the way you use this information and we will not be liable for any loss and destructions of any kind, including but not limited to loss of profit or any other damages occurring in the process. You as a user are the sole person responsible for the risks involved by using this information and we are not liable for breaking the instrument, or other equipments, or properties, or if you hurt yourself or others in the process. All brand names mentioned on this page are property and registered trademarks of their owners. We are not affiliated with neither of them. By using this information you agree and consent with these legal terms.